



SAFE LOCK

by ***Kwikset***

2009 Price Guide



TABLE OF CONTENTS

Warranty	1
Pricing	2
Service Parts	3
Specifications	4-6
Options	7
Backset	7
Keying Charges	7
Ordering Information	8
Weights & Measures	9
General Information	10

SAFE LOCK by **Kwikset**

PRODUCT WARRANTY

Safe Lock products are backed by one of the most comprehensive warranty programs available. You can feel confident that with the purchase of Safe Lock you have selected the best quality product, backed by the best customer service available.







25 Year-Limited Mechanical & 5 Year-Limited Finish Warranty

This product comes with a 25 Year-Limited mechanical warranty and 5 Year-Limited finish warranty to the original residential user of Safe Lock by Kwikset Products against defects in material and workmanship as long as the original user occupies the residential premises upon which the product was originally installed. This warranty DOES NOT COVER scratches; abrasions; deterioration due to the use of paints, solvents, or other chemicals; abuse; misuse; or product(s) used in commercial applications. "Commercial" is defined as any application other than those found on private residences. Upon return of a defective product to us, we may repair or replace the product or refund the purchase price. Safe Lock is not liable for incidental or consequential damages. Some states do not allow the exclusion or limitation of incidental or consequential damages, so the above exclusion may not apply to you. This warranty gives you specific legal rights and you may also have other rights that vary from state to state. If a mechanical or finish defect occurs, please call 1-800-327-5625 in the U.S. and Canada or return it to Safe Lock by Kwikset, Consumer Services, 19701 DaVinci, Lake Forest, California 92610. For customers outside of the U.S. and Canada, claims under this warranty must be made only to either the place of purchase or to the listed importer.

Safe Lock Consumer Services
19701 DaVinci
Lake Forest, California 92610
1-800-327-5625

PRICING

SAFE LOCK
Kwikset

Product	Model	Function	Finish				Case	
			3	11P	15	26D	PKG	QTY
REGINA™ KNOB								
	SK1000RG	Hall/Closet	\$13.60	\$16.70	\$15.20	\$13.60	BP	30
	SK3000RG	Bed/Bath	\$14.70	\$17.80	\$16.20	\$14.70	BP	30
	SK5000RG	Entry	\$17.60	\$21.20	\$19.30	\$17.60	BP	30
	SK7000RG	Dummy	\$6.10	\$7.40	\$6.70	\$6.10	BP	20
	SK1002RG	UL Hall/Closet	\$17.40	\$21.00	\$19.10	\$17.40	BP	30
	SK5002RG	UL Entry	\$23.30	\$27.30	\$24.90	\$23.30	BP	30
ATHENS™ KNOB								
	SK1000AS	Hall/Closet	\$14.40	\$17.80	\$16.20	\$14.40	BP	30
	SK3000AS	Bed/Bath	\$15.60	\$18.40	\$16.70	\$15.60	BP	30
	SK5000AS	Entry	\$19.10	\$22.50	\$20.50	\$19.10	BP	30
	SK7000AS	Dummy	\$6.80	\$8.10	\$7.40	\$6.80	BP	20
	SK1002AS	UL Hall/Closet	\$18.20	\$22.00	\$20.00	\$18.20	BP	30
	SK5002AS	UL Entry	\$24.70	\$28.80	\$26.20	\$24.70	BP	30
WINSTON™ LEVER								
	SL1000WI	Hall/Closet	\$19.80	\$23.30	\$21.20	\$19.80	BP	20
	SL3000WI	Bed/Bath	\$20.40	\$24.60	\$22.40	\$20.40	BP	20
	SL5000WI	Entry	\$22.70	\$27.60	\$25.10	\$22.70	BP	20
	SL7000WI	Dummy	\$9.70	\$12.00	\$10.90	\$9.70	BP	20
	SL1002WI	UL Hall/Closet	\$23.60	\$27.50	\$25.00	\$23.60	BP	20
	SL5002WI	UL Entry	\$28.30	\$33.90	\$30.80	\$28.30	BP	20
GRAPEVINE™ LEVER								
	SL1000GV	Hall/Closet	\$21.10	\$25.10	\$22.80	\$21.10	BP	20
	SL3000GV	Bed/Bath	\$22.10	\$26.30	\$23.90	\$22.10	BP	20
	SL5000GV	Entry	\$25.40	\$29.70	\$27.00	\$25.40	BP	20
	SL7000GV	Dummy	\$11.10	\$13.10	\$11.90	\$11.10	BP	20
	SL1002GV	UL Hall/Closet	\$24.90	\$29.30	\$26.60	\$24.90	BP	20
	SL5002GV	UL Entry	\$31.10	\$36.00	\$32.70	\$31.10	BP	20
DEADBOLTS								
	SD9100	Single Cylinder	\$17.70	\$21.50	\$19.60	\$17.70	BP	12
	SD9200	Double Cylinder	\$20.20	\$24.00	\$21.90	\$20.20	BP	12
	SD9300	One Sided	\$10.60	\$12.70	\$11.50	\$10.60	BP	12
	SD9102	UL Single Cylinder	\$23.40	\$27.70	\$25.20	\$23.40	BP	12
DAYTONA™ HANDLESET								
	(Single Cylinder)	Interior	3	11P	15	26D	PKG	QTY
	SH1100DT	LIP	\$63.00	\$80.00	\$71.00	\$63.00	BP	6
	SK1150RG	Interior Pack	\$23.00	\$23.00	\$23.00	\$23.00	BP	6
	SK1150AS	Interior Pack	\$23.00	\$23.00	\$23.00	\$23.00	BP	6
	SL1150WI	Interior Pack	\$25.00	\$25.00	\$25.00	\$25.00	BP	6
	SL1150GV	Interior Pack	\$25.00	\$25.00	\$25.00	\$25.00	BP	6

Model	MFG Pro Description	Finish					Price
Kwikset Cylinders		3	11P	15	26D	N/A	
A42210	Cylinder, Knob/Lever .180 TOP PIN, Kwikset	•	•	•	•		\$2.70
A42212	Single Cylinder, Deadbolt .180 TOP PIN, Kwikset	•	•	•	•		\$2.70
A42145	Double Cylinder, Deadbolt .180 TOP PIN, Kwikset	•	•	•	•		\$5.40
Screw Cylinders		3	11P	15	26D	N/A	
042221	Screwpack, Knob and Lever	•	•	•	•		\$0.50
042223	Screwpack, Dummy	•	•	•	•		\$0.20
042222	Screwpack, Deadbolt	•	•	•	•		\$0.50
042269	Screwpack, Double Cylinder Deadbolt	•	•	•	•		\$0.70
042268	Screwpack, 1-Sided Deadbolt	•	•	•	•		\$1.10
042182	Screwpack, Handleset, Mounting	•	•	•	•		\$0.20
042267	Screwpack, Handleset, Sex Nut	•	•	•	•		\$0.50
Latches		3	11P	15	26D	N/A	
A42228	RCAL Deadlatch	•	•	•	•		\$4.30
A42230	Drive-In Deadlatch					•	\$4.30
A42233	RCAL Plain Latch	•	•	•	•		\$3.70
A42235	Drive-In Plain Latch					•	\$3.70
A42236	RCAL Deadbolt	•	•	•	•		\$4.90
A42238	RFAL Deadbolt					•	\$4.90
A42277	Drive-In Split-Hub Latch (Handle Sets)					•	\$3.70
A42275	RCAL Split-Hub Latch (Handle Sets)	•	•	•	•		\$3.70
UL Latches		3	11P	15	26D	N/A	
A42270	RCAL Plain Latch, UL	•	•	•	•		\$9.00
A42273	RCAL Dead Latch, UL	•	•	•	•		\$9.00
A29962	RCAL Deadbolt, UL	•	•	•	•		\$9.00
UL Shields		3	11P	15	26D	N/A	
042064	Knob/Lever UL shield					•	\$0.50
029957	1 1/2" Deadbolt UL Shield					•	\$0.50
023344	2 1/8" Deadbolt UL Shield					•	\$0.50
Strikes		3	11P	15	26D	N/A	
042239	Strike, Deadbolt, Round Corner	•	•	•	•		\$2.60
044241	Strike, Deadbolt, Full Lip Round Corner (5303)	•	•	•	•		\$2.60
042231	Strike, Full-Lip, Round Corner	•	•	•	•		\$2.60
UL Strikes		3	11P	15	26D	N/A	
83031	UL Strike, Round Corner, Kwikset	•	•	•	•		\$2.80
Cylinder End Caps		3	11P	15	26D	N/A	
042301	Cylinder End Cap, Kwikset Knob					•	\$0.50
042302	Cylinder End Cap, Kwikset Lever					•	\$0.50
Key Blanks		3	11P	15	26D	N/A	
29595	Key Blank, Safe Lock					•	\$1.00

SPECIFICATIONS

	HANDLESET	DEADBOLT	KNOB	LEVER
Door Prep	Cross Bore 2-1/8". Edge Bore 1". Latch Face 1" x 2-1/4".	Single & Double Cylinder: Cross Bore 2-1/8". Edge Bore 1". Latch Face 1" x 2-1/4". One Sided Deadbolt: Half Cross Bore 1-5/8". Edge Bore 1". Latch Face 1" x 2-1/4".	Cross Bore 2-1/8". Edge Bore 1". Latch Face 1" x 2-1/4".	Cross Bore 2-1/8". Edge Bore 1". Latch Face 1" x 2-1/4".
Backset	Deadbolt: Adjustable to 2-3/8" or 2-3/4". Handle: Adjustable to 2-3/8" or 2-3/4".	Adjustable to 2-3/8" or 2-3/4".	Adjustable to 2-3/8" or 2-3/4".	Adjustable to 2-3/8" or 2-3/4". UL 2-3/4" standard 2-3/8" optional.
Door Thickness	1-3/8" - 1-3/4" doors standard. No thick door option	1-3/8" - 1-3/4" doors standard. No thick door option	1-3/8" - 1-3/4" doors standard. No thick door option	1-3/8" - 1-3/4" doors standard. No thick door option
Cylinder	Kwikset (5 pin).	Kwikset (5 pin).	Kwikset (5 pin).	Kwikset (5 pin).
Faceplates	1"x 2-1/4". Specify round corner or drive in	1"x 2-1/4". Specify round corner or drive in	1"x 2-1/4". Specify round corner or drive in	1"x 2-1/4". Specify round corner or drive in
Strikes	Deadbolt: 1" x 2-1/4". Specify round corner, or full lip (5303) Handle: 2-1/4" full lip. Specify round corner	1" x 2-1/4". Specify round corner, or full lip.	2-1/4" full lip. Specify round corner.	2-1/4" full lip. Specify round corner.
Bolt	Deadbolt: 1" throw. Handle: 1/2" throw.	1" throw.	1/2" throw.	1/2" throw.
Door Handing	Non-handed.	Non-handed.	Non-handed.	Non-handed.
ANSI/BHMA	A156.5 Grade 3 for deadbolt.	A156.5 Grade 3.	N156.2 Grade 3.	A156.2 Grade 3.
ADA	N/A	Interior turn piece meets 4.13.9 ADA.	N/A	1000 and 7000 Functions satisfy section 4.13.9 ADA requirements
UL	N/A	Meets UL 3 Hour fire rating for all UL functions. ULRef. # 10923	Meets UL 3 Hour fire rating for all UL functions. ULRef. #R7860	Meets UL 3 Hour fire rating for all UL functions. ULRef. # R7860

Daytona Handleset

FUNCTIONS

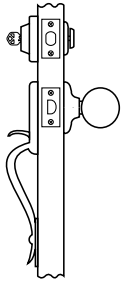

Model

Daytona

Function 1100/1150

Sectional Handleset with Single Cylinder Deadbolt

Description

Latchbolt operated by thumbpiece outside and grip inside. Deadbolt operated by key outside and thumbturn inside.

DIMENSIONS

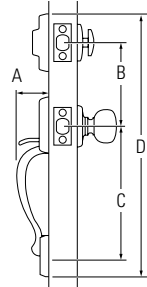

Design	A	B	C	D
Daytona™	2-1/8"	5-1/2"	8-11/16"	17-1/8"

Regina & Athens Knobs

FUNCTIONS

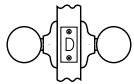

Passage/Hall/Closet: Bath knobs always free.
– **1000/1002UL** *F75*

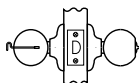

Privacy/Bed/Bath: Both knobs locked or unlocked by turnbutton inside. Outside knob unlocked by emergency key.
– **3000** *F76*

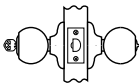

Entry: Both knobs locked or unlocked by key outside or turnbutton inside.
– **5000/5002UL** *F82*



Half Dummy Trim, Surface Mounted: For doors where only a pull is required. No operation. – **7000** *Int.*

Note: ANSI /BHMA functions are listed in italics.

DIMENSIONS

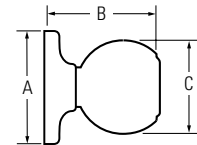

Design	A	B	C
Athens™	2-9/16"	2-3/8"	2"
Regina™	2-9/16"	2-7/8"	1-3/4"

Winston & Grapevine Levers

FUNCTIONS



Passage/Hall/Closet: Both levers always free.
– **1000/1002UL F75**



Privacy/Bed/Bath: Both levers locked or unlocked by turnbutton inside. Outside lever unlocked by emergency key.
– **3000 F76**



Keyed Entry Lever: Both sides locked or unlocked by key outside or turnbutton inside. – **5000/5002UL F82**



Half Dummy Trim, Surface Mounted: For doors where only a pull is required. No operation. – **7000 Int.**

Note: ANSI /BHMA functions are listed in italics.

DIMENSIONS

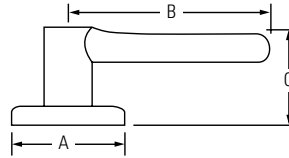

Design	A	B	C	C (Keyed)
Grapevine™	2-9/16"	3-3/4"	2-1/2"	2-1/2"
Winston™	2-9/16"	3-5/8"	2-3/8"	2-3/8"

Deadbolts

FUNCTIONS



Single Cylinder: Deadbolt operated by key outside and thumbturn inside.
– **9100/9102UL E0153**

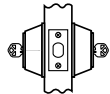

Double Cylinder: Deadbolt operated by key both sides.
– **9200 E0143**



One Sided: Deadbolt operated by thumbturn one side. No trim on other side. Half bore door prep.
– **9300 E0193**

Note: ANSI/BHMA functions are listed in italics.

DIMENSIONS

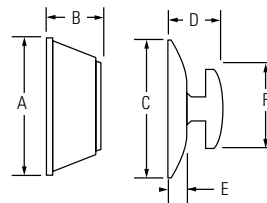

Design	A	B	C	D	E	F
Single Cylinder	2-1/2"	1-1/8"	2-9/16"	3/4"	1/4"	2-1/8"
Double Cylinder	2-1/2"	1-1/8"	2-9/16"	1"		
One Sided			2-9/16"	3/4"	1/4"	2-1/8"

KEYING CHARGES

KWIKSET	LIST PRICE
KD-Keyed Differently	No charge
K2-K6-Keyed Alike	No charge
WITH-Keyed with other item	No charge
KMISC- K6	No charge
MK-Master Keyed	\$1.70
PK-Builder Keyed	\$2.30
GMK-Grand Master Keyed	\$6.50
PMK-Builder Master Keyed	\$4.00
MAIS- Maison Keyed	\$4.80

All locks are shipped KD unless otherwise specified.

BACKSET

Backset is the distance from center edge of door to center of the 2-1/8" (54mm) diameter hole, 2-3/8" or 2-3/4" in most cases.

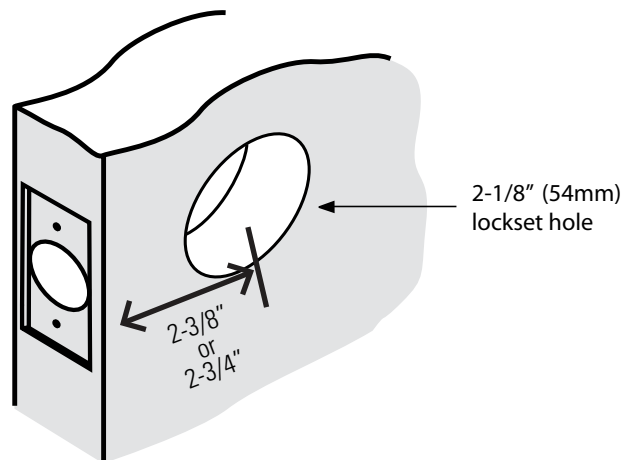

ORDERING INFORMATION

SAFE LOCK
Kwikset

Order Sequence: Function + Style + Finish + Keyway + Keying + Latch + Strike. See examples below

Step 1: US Function

Model #	Non UL Products
SK1000	Knob Passage
SK3000	Knob Privacy
SK7000	Knob Dummy
SK5000	Knob Entry
SL1000	Lever Passage
SL3000	Lever Privacy
SL7000	Lever Dummy
SL5000	Lever Entry
SH1100	Handleset
SL1150	Interior Pack Lever
SK1150	Interior Pack Knob
SD9100	Deadbolt Single
SD9200	Deadbolt Double
SD9300	Deadbolt One Sided

Model #	UL Products
SK1002	Knob Passage
SK5002	Knob Entry
SL1002	Lever Passage
SL5002	Lever Entry
SD9102	Deadbolt Single

Step 2: Style

Style Symbol	Style Name
Knobs	
RG	Regina
AS	Athens
Lever	
WI	Winston
GV	Grapevine
Handleset	
DT	Daytona
Deadbolt	
SD	

Step 3: Finishes

Finish #	Finish Name
3	Bright Brass
11P	Venetian Bronze
15	Satin Nickel
26D	Satin Chrome

Step 4: Keying

Kwikset	
Key Code	Description
KD	Keyed Different
K2,K3,K4,K5,K6	Keyed Alike
MK	Master Keyed
PK	Builder Key
GMK	Grand Master Key
PMK	Builder Master Keyed
MAIS	Maison Keyed
WITH	Tie-up
KMISC	More than 6 cylinders keyed alike

Step 5: Latch

Latch Code	Latch Style
RCAL	Round Corner Adjustable Latch
RFAL	Round Face Adjustable Latch

Step 6: Strike

Strike Code	Strike Style
RCS	Round Corner Strike
5303	Full-Lip (Deadbolt/Handlesets Only)

Example 1: Kwikset keyway; master keyed

Order Entry: 4 SL 5000 GV 15 KW MK RCAL RCS (MK key cut = 56787) Order Description: 4 Safe Lock Grapevine levers, satin nickel, entry function with Kwikset keyway, master keyed and cut 56787, round corner adjustable latch and round corner strike

Example 2: UL product order

Order Entry: 4 SL5002 WI 26D KW KD RCAL RCS Order Description: 4 Safe Lock UL Winston levers in satin chrome, entry function, keyed different, round corner adjustable latch with round corner strike

BOX PACK		UNIT				MASTER CASE				
KNOBS										
	Quantity	Length (in.)	Width (in.)	Height (In.)	Wt.(lbs.)	Quantity	Length	Width (in.)	Height (In.)	Wt.(lbs.)
Entry	1	7.25	3.19	3.13	0.96	30	15.25	10.50	16.50	33.40
Privacy	1	7.25	3.19	3.13	0.96	30	15.25	10.50	16.50	33.40
Passage	1	7.25	3.19	3.13	0.96	30	15.25	10.50	16.50	33.40
Dummy	1	2.75	2.75	3.19	0.28	20	14.25	6.38	7.25	6.00
LEVERS										
	Quantity	Length (in.)	Width (in.)	Height (In.)	Wt.(lbs.)	Quantity	Length	Width (in.)	Height (In.)	Wt.(lbs.)
Entry	1	6.88	5.06	3.13	1.42	20	14.50	11.00	16.50	32.00
Privacy	1	6.88	5.06	3.13	1.42	20	14.50	11.00	16.50	32.00
Passage	1	6.88	5.06	3.13	1.42	20	14.50	11.00	16.50	32.00
Dummy	1	5.50	3.13	3.00	0.58	20	14.50	12.00	7.00	12.70
HANDLESETS										
	Quantity	Length (in.)	Width (in.)	Height (In.)	Wt.(lbs.)	Quantity	Length	Width (in.)	Height (In.)	Wt.(lbs.)
Handleset	1	14.19	6.88	3.25	3.42	6	14.50	10.50	14.50	22.40
Interior Pack	1	5.51	2.76	2.76	0.60	6	8.66	6.3	6.3	5.29
DEADBOLTS										
	Quantity	Length (in.)	Width (in.)	Height (In.)	Wt.(lbs.)	Quantity	Length	Width (in.)	Height (In.)	Wt.(lbs.)
Single Cylinder	1	3.88	3.44	2.56	0.88	12	14.00	12.63	3.50	16.40
Double Cylinder	1	3.88	3.44	2.56	1.46	12	14.00	12.63	3.50	21.70
Half	1	3.88	3.44	2.56	0.61	12	14.00	12.63	3.50	9.30

TERMS AND CONDITIONS OF SALE

Standard terms are 2% prompt payment discount for payment within 25 days from date of invoice; net 30 days from the date of invoice. Safe Lock by Kwikset® reserves the right to charge and recover on invoices which are not paid within the above terms, a service charge of 1-1/2% a month for each month or fraction thereof during which the invoice remains unpaid, said service charge, however, not to exceed the highest applicable legal rate of interest. All orders, whether solicited or written by our sales representatives or forwarded by our customers are deemed to be mere offers to purchase in accordance with these Terms and Conditions of Sale until actually accepted by us at our home office in Lake Forest, CA. We reserve the right to refuse any order as well as the right to sell or not sell to any firm at our sole discretion. The acceptance of an order is expressly made conditional upon your assent to these Terms and Conditions of Sale. We object to the inclusion of any different or additional terms or conditions, even if the same are included in your order, a contract of sale will result upon the Terms and Conditions of Sale stated herein only. Prices reflected in this book apply to Wholesale customers only.

All sales are final.

PRICES

Pricing based on full-case quantities only; orders for less than full case will be automatically adjusted up to the next full-case quantity. All prices are subject to change without notice and are not guaranteed. All taxes, duties or other charges are the responsibility of the customer.

CLAIMS

Price claims must be submitted in writing to Safe Lock by Kwikset, 19701 Davinci, Lake Forest, CA 92610 within 30 days from the date of invoice.

CHANGES OR CANCELLATIONS

Beyond 5 working days of our acknowledgement date no changes can be made. Additions to an order will be handled as a separate order and must meet applicable minimum order requirements. Order cancellation on regular stock items only, or any portion thereof is allowed only upon prior written consent from Safe Lock by Kwikset, and the payment of cancellation charges deemed appropriate.

MINIMUM CHARGE

No order will be invoiced for less than \$100.00 net plus shipping charges except for lock accessory parts.

MINIMUM ANNUAL SALES VOLUME

The company reserves the right to discontinue direct sales to any customer who does not meet the minimum annual sales volume requirement. The current annual requirement is \$50,000.00. Your annual purchases are determined by accepted, non-cancelled, and shipped orders received during each calendar year. Safe Lock by Kwikset reserves the right to change any or all minimum annual sales volume requirements at any time. Any customer who does not meet the annual sales volume requirements may continue to purchase Safe Lock by Kwikset products through a Safe Lock by Kwikset distributor.

RETURNS

Defective merchandise returned to our factories requires prior written authorization from a Safe Lock by Kwikset Sales Rep or the Sales Office. A factory return authorization must accompany the returned shipment. The return authorization must include an itemized listing of the merchandise and an explanation stating the reason for return.

FREIGHT

All goods are invoiced FOB our factory. Upon delivery of shipments to the carrier, title to, and the risk of loss or damage in transit for such shipments, passes to our customer. Safe Lock by Kwikset's standard policy is to pay freight charges on all shipments of 300 locks (Accessories: 300 lbs.) to a single destination in the continental U.S., by carrier and route of our choice. Shipments less than these quantities will not be shipped on a prepaid basis.

If higher freight charges are incurred from customers specifying a carrier or route of their choice the additional cost will be added to that customer's invoice.

DELIVERY CONDITIONS

Shipping schedules are our best estimates, and cannot be guaranteed. Safe Lock by Kwikset is not responsible for any direct or consequential loss or damage resulting from an inability or delay in meeting shipping schedules.

PRODUCT WARRANTY

Warranties cover the original residential user of Safe Lock by Kwikset Products against defects in material and workmanship as long as the original user occupies the residential premises upon which the Product was originally installed. This warranty DOES NOT COVER abused or misused products or non-commercial products used in

commercial applications. Upon return of a defective Product to Safe Lock by Kwikset Corporation, Safe Lock by Kwikset shall either replace the Product or refund the purchase price, at our discretion. If a covered defect occurs, call 1-800-327-5625 in the U.S. and Canada or return it to Safe Lock by Kwikset Corporation, Consumer Services, 19701 DaVinci, Lake Forest, California 92610. A finish deterioration occurring from the use of paints, solvents, or other chemicals is not a defect in the finish and is not covered by this warranty. Safe Lock by Kwikset is not liable for incidental or consequential damages. Some states do not allow the exclusion or limitation of incidental or consequential damages, so the above exclusion may not apply to you. This warranty gives you specific legal rights and you may also have other rights that vary from state to state.

PATENT INDEMNITY

We agree to defend any suit or proceeding brought against our customer so far as based on claim that our products, or any part thereof, made solely to our specifications and furnished to our customer constitute an infringement of any U.S. patent, if notified promptly in writing and given authority, information and assistance at our expense for the defense of same, and we shall pay all damages and costs awarded therein against our customer. In case our products, or any part thereof, is in such suit held to constitute infringement and their use is enjoined, we will, at our expense and discretion, either procure for our customer the right to continue using the products or replace same with non-infringing products, or modify them so they become non-infringing, or remove such products and refund the purchase price (less depreciation, prorated from the purchase date). The foregoing states our entire liability for patent infringement by our products or any part thereof.

STANDARDS

Safe Lock by Kwikset meets or exceeds the testing requirements specified for each product grade or rating.

- American National Standards Institute (ANSI)
- Builders Hardware Manufacturers Association (BHMA)
- Underwriters Laboratories, Inc. (UL)
- ADA (Americans with Disabilities Act)

MISCELLANEOUS

Substitution of non-Safe Lock by Kwikset components/parts, and any alteration or modification of factory parts, and other lock manufacturer's parts may result in door hardware which does not function properly or will fail and will void all warranties.

Orders not specified with keying requirements will be shipped Keyed Differently (KD). Orders with keying requirements of K10 or more must have a "Letter of Release" on file with Safe Lock by Kwikset stating that Safe Lock by Kwikset Corporation will not be held liable for cost and expense arising from any loss or damage to property utilizing Safe Lock by Kwikset products where 10 or more locks have been keyed alike. Contact your Sales Office account representative for a copy of the release form. Safe Lock by Kwikset reserves the right to revise or modify products, product information, or pricing without notice. Product specifications and pricing reflect available information at the time of printing. Safe Lock by Kwikset is not responsible for typographic or printing errors.

Notes

